

# Data Sheet



Article number: 071481450490080

Description: Cardan drive shaft 0.148.145.001  
S=490 X=80 Bore with keyway

## Measures

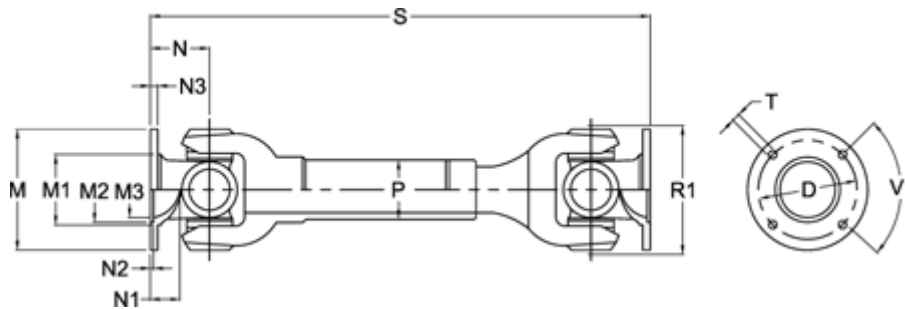

D	= 130 +/-0,1	N1	= 32	T	= 12 B12
Extension X	= 80	N2	= 3 +0,5	V1 degrees	= 45
Flange diameter M	= 150	N3	= 10		
M1	= 104	Number og Flangeholes	= 8		
M2	= 90	P	= 80x4		
M3	= 76	R1	= 138		
Max. Bending Angle degrees	= 35	S min	= 490		
N	= 65	Spline dim. DIN 5480	= 55x2,5x20		